

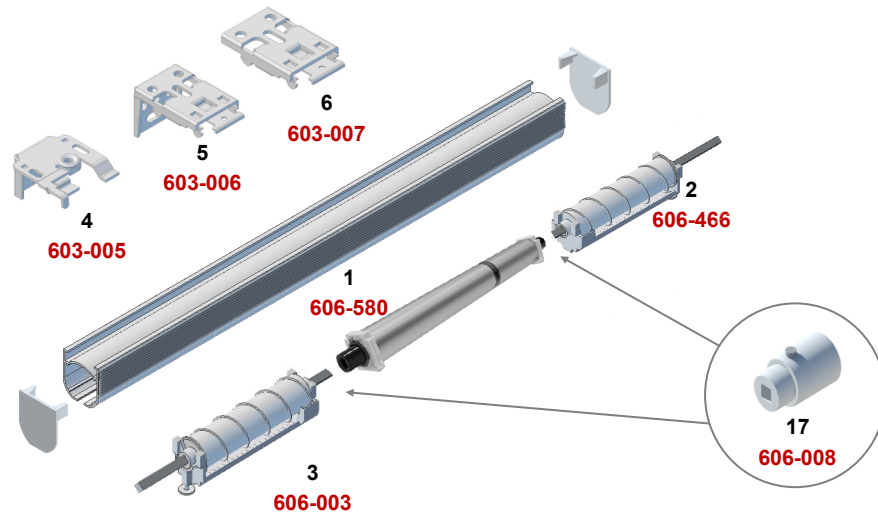

# 606 ROMA Dual

## Komplety s motorovým ovládáním



Sestavy s motorem bez přijímače obsahují navíc spodní doraz (brzdu).

Objednací kód				
Typ motoru	Typ osazení setu	Typ profilu roletky	Šířka roletky	Typ držáku
M1	R 2	606	215	D1
<b>M1</b> bez dálkového ovládání  <b>M2</b> s dálkovým ovládáním	<b>R1</b> - plně vybavený set pro skládanou roletku  <b>R2</b> - speciální set s jedním navijáčem navíc, pro řasené roletky	<b>606</b> - uzavřený	<b>75*</b> - 300 cm	<b>D2</b> <b>D3</b> <b>D4</b>

\* Pozor, minimální šířka roletky je **75 cm**, tak aby se dovnitř profilu vešly dva navijáče, motor, příp. brzda motoru.



Transformátor, wi-fi spínač a dálkový ovladač nejsou součástí sestav. Je třeba je objednat zvlášť.



## 606 ROMA Dual

### Komplety s motorovým ovládáním

Komplety s motorem M1 - bez přijímače: 





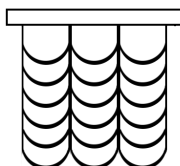

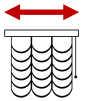
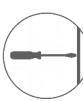

Typ rolety

#### M1-R2- 606



Set **M1-R2-606**:

obsahuje profil **606-580**, krytku profilu 2 ks, motor **M1-600**, brzdu motoru, poj. kroužek **606-008** 2 ks, navíječ **606-003** (v počtu viz tabulka) s hřídelkou **606-466**, závaží kulička **600-014** ve shodném počtu jako je počet navíječů, vybraný držák

Navíječ ks	Šíře v cm	Vybraný držák	Motor	Objednací kód	Cena
 <b>606-003</b>					
3	80		 <b>M1</b>	<b>M1-R2-606-080-..</b>	<b>Na dotaz u nás nebo u našich partnerů.</b>
3	90			<b>M1-R2-606-090-..</b>	
3	100			<b>M1-R2-606-100-..</b>	
4	110			<b>M1-R2-606-110-..</b>	
4	120			<b>M1-R2-606-120-..</b>	
4	130			<b>M1-R2-606-130-..</b>	
4	140			<b>M1-R2-606-140-..</b>	
4	160			<b>M1-R2-606-160-..</b>	
5	180			<b>M1-R2-606-180-..</b>	
5	200			<b>M1-R2-606-200-..</b>	
5	220			<b>M1-R2-606-220-..</b>	
6	240			<b>M1-R2-606-240-..</b>	
6	260			<b>M1-R2-606-260-..</b>	
6	280			<b>M1-R2-606-280-..</b>	
6	300			<b>M1-R2-606-300-..</b>	

### Komplety s motorem M2 - s přijímačem:





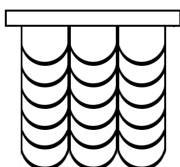

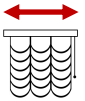
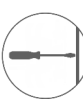

Typ rolety

#### M2-R2- 606



Set **M2-R2-603**:

obsahuje profil **606-580**, krytku profilu 2 ks, motor **M2-600**, poj. kroužek **606-008** 2 ks, navíječ **606-003** (v počtu viz tabulka) s hřídelkou **606-466**, závaží kulička **600-014** ve shodném počtu jako je počet navíječů, vybraný držák

Navíječ ks	Šíře v cm	Vybraný držák	Motor	Objednací kód	Cena
 <b>606-003</b>					
3	80		 <b>M2</b>	<b>M2-R2-606-080-..</b>	<b>Na dotaz u nás nebo u našich partnerů.</b>
3	90			<b>M2-R2-606-090-..</b>	
3	100			<b>M2-R2-606-100-..</b>	
4	110			<b>M2-R2-606-110-..</b>	
4	120			<b>M2-R2-606-120-..</b>	
4	130			<b>M2-R2-606-130-..</b>	
4	140			<b>M2-R2-606-140-..</b>	
4	160			<b>M2-R2-606-160-..</b>	
5	180			<b>M2-R2-606-180-..</b>	
5	200			<b>M2-R2-606-200-..</b>	
5	220			<b>M2-R2-606-220-..</b>	
6	240			<b>M2-R2-606-240-..</b>	
6	260			<b>M2-R2-606-260-..</b>	
6	280			<b>M2-R2-606-280-..</b>	
6	300			<b>M2-R2-606-300-..</b>	

# ROMA

## Příslušenství

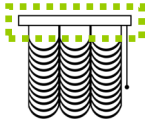

### Pásky vodorovné - pro sestavy R2



Obj. kód	balení	Šíře	Materiál	
<b>1124/45 VC</b>	Řasící se suchým zipem	50 m	45 mm	PES

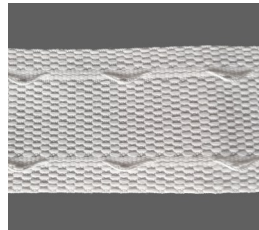

1124/45 VC

### Pásky svislé - pro sestavy R2

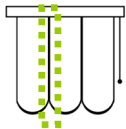

Zdvihací:



Obj. kód	balení	Šíře	Rozteč vodících kroužků/ poutek	Materiál	
<b>1023/16 TR</b>	S vodícími kroužky, transparentní	100 m	16 mm	16 cm	PES



1023/16 TR



## 606 ROMA Dual

### Komponenty - ovládání motorem



Obj. kód	MJ
26 <b>M-TRF-24</b>	Transformátor - 100/240V -> 24 V ks
27 <b>M-WIFI</b>	Wi-fi spínač dvoukanálový ks
28 <b>M-DO-A5-CE/B</b>	Dálkový ovladač, 5kanálový, 868 Hz, černý ks
28 <b>M-DO-A5-B/W</b>	Dálkový ovladač, 5kanálový, 868 Hz, bílý ks
29 <b>M-DO-A9</b>	Dálkový ovladač, 9kanálový, 868 Hz, černý ks
30 <b>M-DO-A99</b>	Dálkový ovladač, 99 kanálový, 868 Hz, černý ks
31 <b>M-DO-A1</b>	Dálkový ovladač, jednocanálový (k instalaci na stěnu), 868 Hz, bílý ks
32 <b>M-DO-A2</b>	Dálkový ovladač, dvoukanálový (k instalaci na stěnu), 868 Hz, bílý ks



Vzhledem ke složitosti kompletace sestav s motorovým ovládáním, nabízíme k prodeji pouze hotové sestavy, nikoliv všechny potřebné komponenty k jejich kompletaci.



M1-600



M2-600



NE

ANO

DC 24 V / 12 V

1,5 N.m

45 rpm

30 - 45 rpm

Délka - 198 mm; průměr - 24 mm

#### Vypínačem

Při zařazení wifi spínače lze ovládat chytrým telefonem či hlasovým asistentem

#### Dálkovým ovladačem



Input: AC 100-240V 50/60Hz

Output: DC 24V/1 A

Rozměry: 129 x 23 x 23 mm

Typ motoru:

Přijímač:

Napětí:

Točivý moment:

Rychlost:

Rozměry motoru:

Ovládání

Transformátor: